

**Maybe your
problem door
isn't a door
problem.**

**Keep your door.
Keep your frame.
Change the hinge.**

**SAVE TIME AND MONEY BY FIXING
YOUR DOOR PROBLEMS FOR GOOD**



SELECT HINGES™

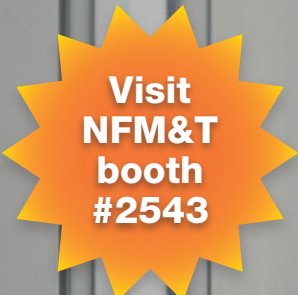

**Visit
NFM&T
booth
#2543**



SELECT hinges' 60-year life cycle means you can fix it and forget it.

Independent lab tests on an FRP door prove SELECT hinges withstand 25,000,000 cycles — 10 times beyond Grade 1 cycle count. That equals more than 60 years of high-traffic use, more traffic than most doors see in a lifetime.

SELECT hinges' durability means we can offer the industry's only Continuous Warranty™. It covers any failure of our aluminum geared continuous hinges — with no expiration date — as long as they were properly installed.

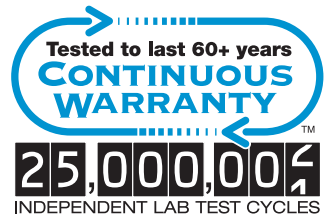

The warranty that never ends for the hinge that never quits.™

CONCEALED HINGES

Edge mount. No mortise required. For new construction or renovation/retrofit.

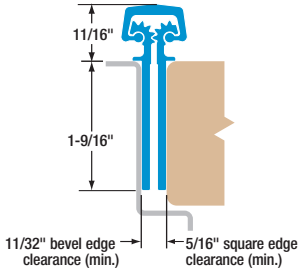

SL11 SD/HD/LL

Flush mounted (no door inset).

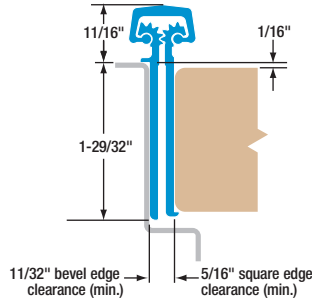

SL24 SD/HD/LL

1/16" door inset. Door edge protector. Frame leaf covers butt hinge preps.

FULL SURFACE HINGES

Mounts on face of door and frame. For renovation/retrofit or new construction.

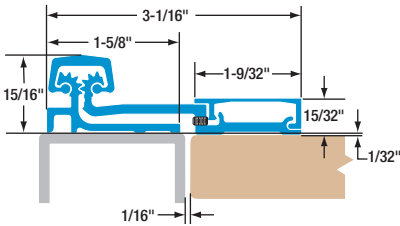

SL21 SD/HD

1/32" door inset. Swing-clear action. Tamper-resistant, removable door leaf cover.

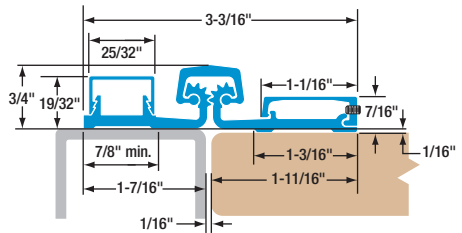

SL57 SD/HD

1/16" door inset. Frame leaf fits narrow (7/8") frame face. Tamper-resistant door leaf cover.

TOILET PARTITIONS

For high-frequency stall doors up to 80 lb., 36" wide.

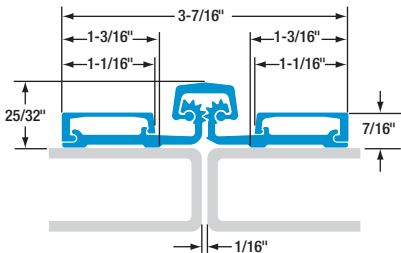

SL60

57" length. Hinge opens to 180°.

SL62

57" length. Self-closing hinge opens to 120°.

HALF SURFACE HINGE

Mounts on door face and frame rabbet. For renovation/retrofit or new construction.

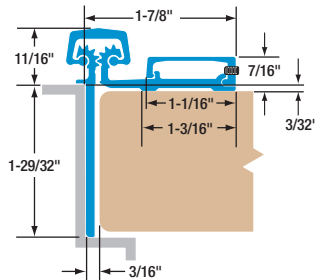

SL54 HD

3/32" door inset. Frame leaf covers butt hinge preps. Tamper-resistant, removable door leaf cover.

SELECT ADVANTAGES



PAIR-MATCHED™ HINGE LEAVES

Manufactured together, machined together and anodized together to fit your doors better and last longer.

**An exclusive
SELECT benefit.**

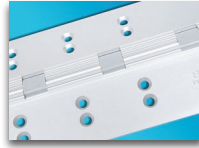

TEMPLATED HOLE PATTERN

Hole pattern is identical on both SD and HD models, so SELECT hinges line up precisely for easier and faster installation.

**An exclusive
SELECT benefit.**



LIFETIME LUBRICATION

Eliminates the need for periodic maintenance. Quiet performance. Fights gear cap wear.

**An exclusive
SELECT benefit.**



COATED FASTENERS

Provide additional corrosion protection with either self-drilling, thread-forming (SDTF) or thread-forming (TF) screws. **An exclusive
SELECT benefit.**

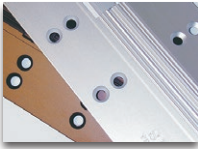

ANODIZED AFTER MACHINING

Delivers superior wear, durability and life. Inhibits corrosion. Few hinge makers follow SELECT's lead in using this superior manufacturing process.



CUSTOM COLORS

Match any paint color on the gear cap or the entire hinge and fasteners, including our always-in-stock Bone White gear caps. Anodized colors also available.



PATENTED 3-HR. FIRE RATING

Available without pins or studs. No extra parts to buy or install. Design innovation approved for positive and negative pressure. **An exclusive
SELECT benefit.**



60+ YEAR PRODUCT LIFE CYCLE

Long life makes them a "green" choice and qualifies toward LEED points for recycled content, low VOC and regional materials.

**The
GREEN Hinge™**
Meets **LEED** requirements



**SELECT
HINGES®**

SELECT Products Limited

Printed on FSC Certified recycled paper.

© 2015 SELECT Products Limited
Printed in U.S.A. #FL-011015

800-423-1174

select-hinges.com

