

# Automatic Entrance Systems

*2013 Edition*





**Rugged Corner Block Construction**

Heavy duty rails with integral corner blocks adds structural integrity to all Horton door systems. This exclusive mortise-style corner block construction is far superior to mass produced through-bolt panels.

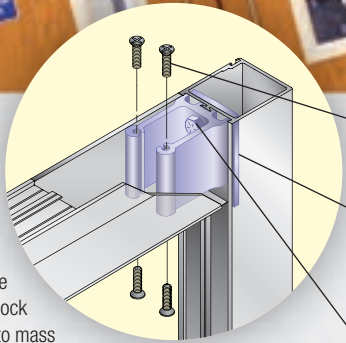

Four #10-24 bolts secure corner block to horizontal rail

Concave steel back-up plate engineered as built-in self locking device for Grade 8 bolts

Two Grade 8, 1/4-20 bolts secure corner block to vertical rail

**Double Astragal Weather Seals Save Energy**

Weather seal material is captured in aluminum extruded astragal that is screw-applied to panel rather than with adhesive as mass produced systems. This creates a positive seal that stands up to wind as well as to the highest traffic conditions.

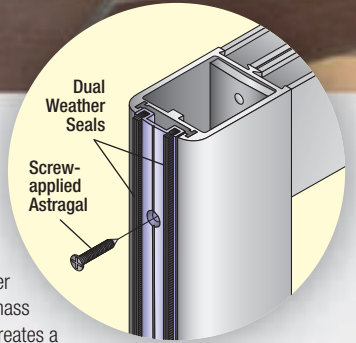

# Tougher. Greener. Horton.

*Did You Know?*

*Horton invented America's first automatic sliding door system in 1960.*

Offering tangible advantages for green design along with a solid reputation for rugged dependability, Horton door systems are the proven choice for a high performance, sustainable building.

Select from a wide range of access solutions including several innovative packages for healthcare facilities, security entrances, service windows, hurricane-rated applications and other installations that are well-known strengths of the Horton brand. All systems feature rugged corner block construction plus superior weather seals in exterior doors for environmental efficiency.

Horton's unique design platform and manufacturing approach makes it easy to obtain custom touches that other door fabricators cannot match. Let us demonstrate our superior quality, service, support and custom capabilities on your next project.

**Product Functions**

Self Closing	Breakout	Automatic	Manual	ADA	Smoke Rated	Security	Energy Efficient	X-Ray



**Solid Metal Carriage Frames  
Reduce Maintenance**

Emergency breakout panels are reinforced with a heavy duty, solid metal top carriage frame. Better than competitive thin-wall extrusions, this exclusive Horton feature protects the guide wheels and withstands breakout forces that otherwise can lead to early replacement.

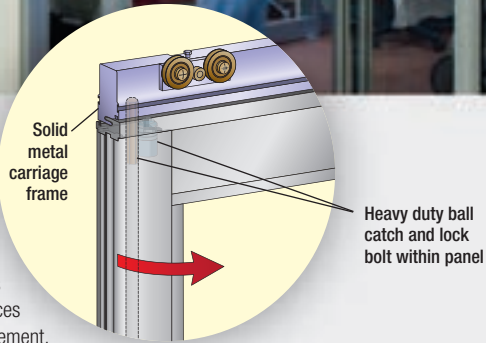

**Custom Finishes To Enhance The Aesthetics Of Your Design**

Horton door systems may be specified with powder coat finishes in a wide range of custom colors including wood grain. Thermally cured for toughness, these earth-friendly PVDF coatings offer superior durability and color retention, even in the harshest environments.



## Standard and Custom Solutions

### Sliding Door Systems ..... 4

- Profilor® Linear Drive ..... 5
- ProSlide™ Belt Drive..... 5
- ProSlide™ Telescoping ..... 5
- Hurricane Rated Systems ..... 6
- Elegant™ All-Glass ..... 6
- HD-Slide™ Heavy Duty Belt Drive ..... 6
- Profilor®-ICU Manual Sliding ..... 7
- Smoke Rated ICU/CCU Systems..... 7

### Swing & Folding Door Systems ..... 8

- HD-Swing™ Door Operator ..... 8
- Low Energy Operators ..... 9
- FoldingAccess™ Folding Doors ..... 9
- Other Swing Door Packages ..... 9
- ICU/CCU Bi-Fold/Bi-Swing™ ..... 9
- SmokeSwing ..... 9
- Other Specialty Operators ..... 9

### Revolving Door Systems ..... 10

- Grand® Revolver ..... 10
- MiniGrand® Revolver ..... 10
- ControlFlow™ Security..... 11
- AutoFlow™ Hands Free ..... 12
- EasyFlow™ Manual ..... 12
- Sensors for Revolving Doors ..... 12

### Industrial Sliding Door Systems ..... 13

### Service Windows ..... 14

### Platform Screen Doors ..... 14

### Activation and Sensors ..... 15

### Installation and Service ..... 16

# Sliding Door Systems



Horton Automatics sliding door systems are used in a wide range of commercial and industrial applications. Packages are available from 7 to 16 feet unit widths. Door configurations are offered in 2-, 3-, or 4-panel designs, single sliding or bi-parting with choice of anodized aluminum, paint or metal clad finishes. Narrow, medium, and wide stile panels as well as all-glass Elegant® design are also available.

## Standard Features

- Exclusive high strength corner block construction
- Rugged breakaway system featuring full-width solid torsion bar assembly to provide superior support in the breakaway position
- Dual safety beams for added threshold protection
- User-selectable operating modes



Shown: Type 110 installation with emergency breakout sliding panels.

## Installation Key (Door Types)

Consult factory for other options

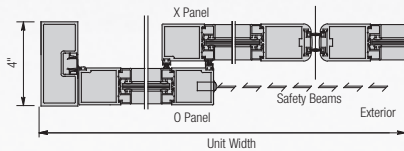

**Type 010**  
No breakout capability.  
Doors slide to interior of fixed sidelites.

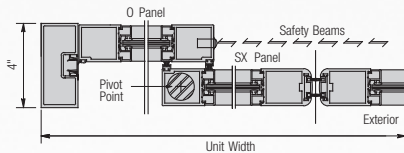

**Type 110** (most common specification)  
Moving panels break out.  
Doors slide to the exterior of fixed sidelites.

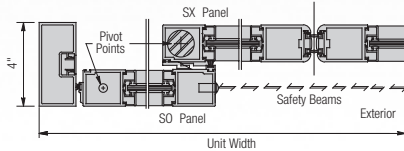

**Type 310**  
Largest break out area for moving wide objects.  
Doors slide to the interior of fixed sidelites.

*“Horton Automatics was instrumental in meeting our client’s stringent requirements for design, delivery and quality. Horton’s custom solution resulted in an aesthetically superior and highly functional hospital environment.”*

*Russ Warrington, President  
Automatic Entries, Inc., Lynnwood, WA*

*Above Photo: Custom Sliding Door System for Patient Rooms at Southwest Washington Medical Center, Vancouver, WA*

## Ultimate Drive Mechanism Dependability



At the heart of these hardworking systems is a choice of three Horton Automatics sliding door operators. All are engineered with 1/8 HP motors (1/4 HP motor option for Series 2001 heavy duty operators) plus microprocessor control and digital display for visual adjustment of settings and diagnostics. An auto-seal feature ensures the doors are closed for energy savings.

### Series 2000 Linear Drive Operator

### Series 200B Elite Drive Operator

- Superior aesthetics
- Panels up to 250 lbs

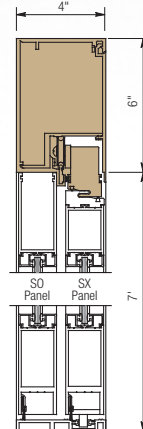

- Supplied with Profiler® and Profiler® Storm linear drive and belt drive door systems
- Slim 4" x 6" flush to jamb header
- Durable stainless steel drive shaft with linear clutch action drive block

For Type 010, 110 or 310 installations

### Series 2003 Belt Drive Operator

- Wider openings
- Panels up to 250 lbs

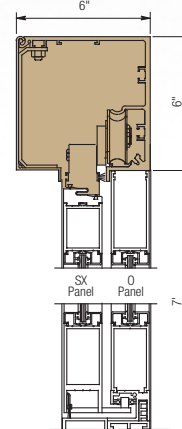

- Supplied with ProSlide™ door systems
- Durable 6" x 6" header
- 1/2" steel reinforced neoprene belt

For Type 110 or 310 installations

### Series 2001 Belt Drive Operator

- Higher traffic
- Heaviest panels to 300 lbs (bipart) or 500 lbs (single slide)

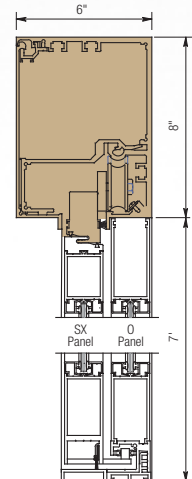

- Supplied with HD-Storm™, HD-Slide™, Elegant™ and custom door systems
- Heavy duty 6" x 8" header
- 1" reinforced neoprene belt

For Type 110 or 310 installations



**Profilor®**  
2000 Linear Drive System  
2000B Elite Belt Drive System

The 4" x 6" header profile allows for flush mounted solutions to jambs without the need for end caps. This door system is often selected for its visual appeal, yet the real advantage is the system's dependability, with fewer parts to wear out and easy adjustments.

**Drive Mechanism**  
Series 2000 linear drive operator  
Series 2000B Elite belt drive operator

- Applications**  
Two-Way General Traffic
- Hospitals
  - Hotels/Resorts
  - Retail
  - Upscale Offices
  - Upscale Residential



**2000-IDS Automated ICU Isolation Door System**

Sliding entrance to a positive/negative pressure isolation room.

- Perimeter seal
- Trackless flow design for unobstructed flow
- Automatic hands-free operation or manual operation

*Featured in Frederick Hospital, MD.*



**ProSlide™**  
2003 Belt Drive System

Ideal for high traffic applications, this heavy duty belt-drive door system is engineered to provide long life and quiet operation.

**Drive Mechanism**  
Series 2003 belt drive

- Applications**  
Two-Way High Traffic
- Airports
  - Supermarkets
  - Hospitals
  - Hotels/Resorts
  - Shopping Malls

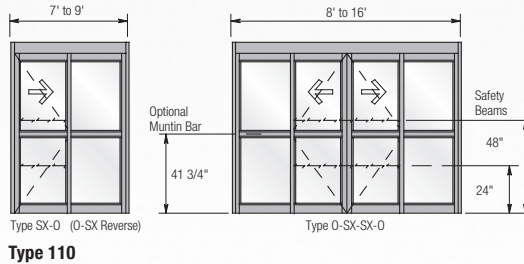

**Type 110**

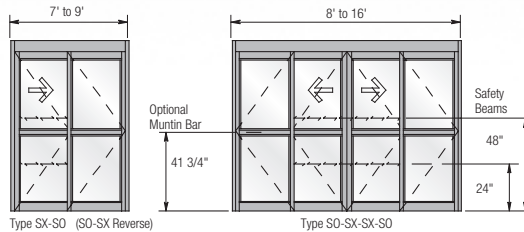

**Type 310**



**ProSlide™ Telescoping**  
2003 Belt Drive System

This system is ideal for automatic sliding door access in narrow passageways, effectively increasing the opening width more than 35 percent. Available in single or bi-parting configurations.

**Drive Mechanism**  
Series 2003 belt drive

- Applications**  
Two-Way Traffic, Maximum Opening
- Hospitals
  - Hotels/Resorts
  - Shopping Malls
  - Office Buildings

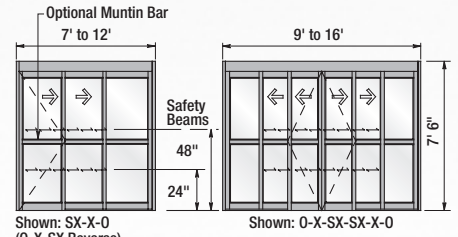

**Type 110T**

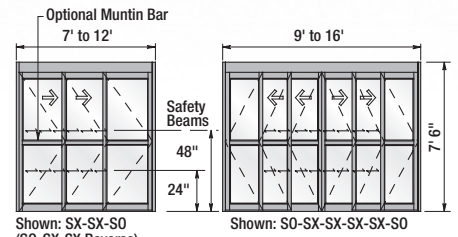

**Type 310T**



Selection Guide		Unit Width	Max. Clear Opening	Type 110 Breakout Opening	Type 310 Breakout Opening
	Model				
	Type				
	Model				
	Type				

See page 15 for choice of activation and sensors

# Sliding Door Systems Continued



## HD-Storm™

Hurricane Rated Door Systems

### Up to ±80 PSF, With 3-Point Locking\*

Offering the largest envelope, highest PSF rating, massive steel rail reinforcement and 3-point locking, this system offers the ultimate protection against high winds and windborn debris.

### Drive Mechanism

Series 2001 belt drive, 6" x 8" header

## Profiler® Storm

### Up to ±55 PSF

An industry standard for Miami-Dade compliance, the Profiler® Storm series boasts several emergency egress designs and locking options, making it ideal for any application.

### Drive Mechanism

Series 2000 linear or Elite belt drive, 4" x 6" header

### HD-Storm™ and Profiler® Storm

#### Applications

- Coastal, Inland Storm Zones
- Commercial/Health Care
- High Rise Residential
- Grocery, Other Retail
- Schools, Government

#### Glass Options

- Large Missile
- Small Missile
- Non-Impact

#### HD-Storm

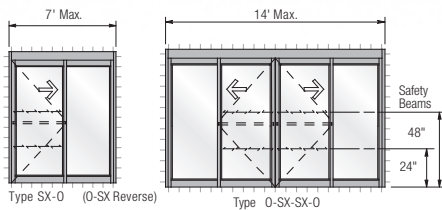

#### Profiler Storm

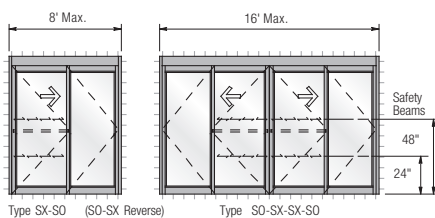

\* 84 PSF for breakout (Type 310) available in Fall 2012



## Elegant™

2001 Belt Drive All-Glass, Full Breakout System

With frameless styling, the Elegant® door system showcases your building's inner beauty while offering the advantages of automatic operation and energy efficiency. Supplied with 1/2" tempered glass.

### Drive Mechanism

Series 2001 belt drive

### Applications

Two-Way Traffic, All-Glass Design

- Hotels/Resorts
- Office Buildings
- Medical Facilities
- Retail

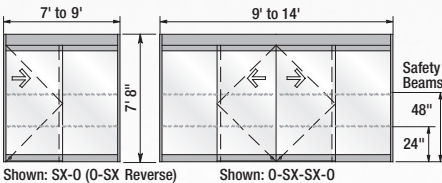

#### Type 110

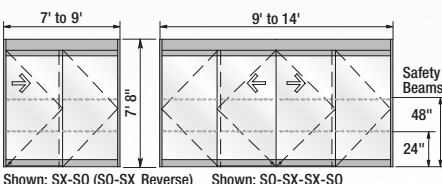

#### Type 310



## HD-Slide™

2001 Heavy Duty Belt Drive System

Developed for use with large commercial and industrial doors up to 500 lbs., this system is engineered with a high capacity header, heavy duty power train and breakouts. An optional 1/4 HP motor is available to accommodate extreme requirements.

### Drive Mechanism

Series 2001 belt drive

### Applications

Two-Way Traffic, Large/Heavy Doors

- Hotels/Resorts
- Office Buildings
- Medical Facilities

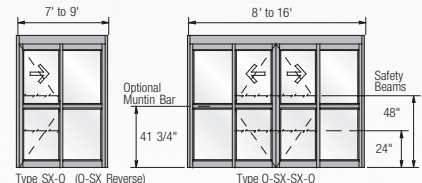

#### Type 110

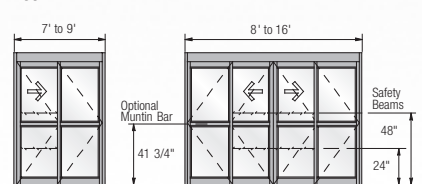

#### Type 310



### Selection Guide

Model	Type	Unit Width	Max. Clear Opening	Type 110 Breakout Opening	Type 310 Breakout Opening
HD-Storm™	Single	7' (2134)	2' 11 1/2" (898)	3' 4 1/2" (1019)	—
	Bi-part	10' to 14' (3048–4267)	3' 11 1/4" to 5' 11 1/4" (1200–1810)	4' 8 3/4" to 6' 8 3/4" (1441–2051)	—
Profiler® Storm	Single	7' to 8' (2134–2438)	2' 10 1/2" to 3' 4 1/2" (876–1028)	3' 3 1/2" to 3' 9 1/4" (997–1149)	6' 3" to 7' 3" (1905–2210)
	Bi-part	8' to 16' (2438–4877)	2' 9 1/2" to 6' 9 1/2" (851–2070)	3' 7" to 7' 7" (1092–2311)	6' 9 1/2" to 12' 9 1/2" (2070–4509)
Elegant™	Single	7' to 9' (2134–2743)	3' to 4' (914–1219)	3' 1 1/2" to 4' 1 1/4" (959–1264)	6' 3" to 8' 3" (1905–2515)
	Bi-part	9' to 14' (2743–4267)	3' 6" to 6' (1067–1829)	3' 10" to 6' 4" (1168–1930)	7' 9 1/2" to 12' 9 1/2" (2375–3899)
HD-Slide™	Single	7' to 9' (2134–2743)	3' to 4' (914–1219)	3' 3 1/2" to 4' 3 1/2" (1003–1308)	6' 3" to 8' 3" (1905–2515)
	Bi-part	8' to 16' (2438–4877)	3' to 7" (914–2134)	3' 7" to 7' 7" (1092–2311)	6' 9 1/2" to 14' 9 1/2" (2070–4509)



## Profiler®-ICU

### Manual & Self Closing Sliding Doors

Designed specifically for the critical care environment of ICU/CCU rooms, these multi-function doors keep patients in full view when doors are closed. The panels swing out to provide maximum clearance for beds and equipment.

- Choice of two, three- or four-panel configurations
- Trackless design option for easier installation and unobstructed mobility and superior hygiene
- Available self closing mechanism
- Available with multiple privacy glass options



*Multi-access design allows clear monitoring of the room and full breakaway to move patients.*



*Optional mini-blind glass provides light control and privacy.*

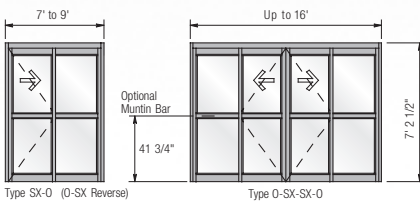

**Type 110**  
Manual & Self Closing

**Type 110**  
Manual

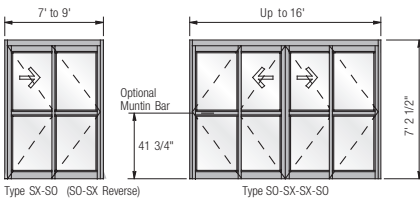

**Type 310**  
Manual & Self Closing

**Type 310**  
Manual



## Profiler®-ICU Smoke Rated

### Manual & Self Closing Sliding Doors

Exceeding the air leakage requirements of NFPA 105 per UL 1784, the Profiler®-ICU smoke rated door system features:

- Concealed high-temperature gasket or brush design
- Positive latching handles
- Slide doors available in trackless or recessed track configurations
- Available self closing mechanism



*Modified door nosings, bottom rails and interlock seals exceed smoke infiltration requirements of NFPA105.*

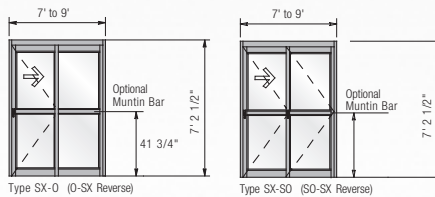

**Type 110**  
Manual

**Type 310**  
Manual & Self Closing



## Profiler® Smoke Rated

### Telescoping ICU/CCU

#### Manual Telescoping Doors

The first smoke-rated ICU/CCU door system offered in a telescoping design, this system extends access up to 80 inches, with standard and custom packages offered from 7 to 12 feet.

- Up to 78% greater access width than standard smoke-rated single sliding ICU doors
- Smoke rating per UL 1784 and NFPA 105 standards
- Trackless floor design for unobstructed traffic flow
- Low profile header for superior aesthetics
- Positive latching handles and interlock seals



*Telescoping system provides up to 80 inches of clear opening width for beds and equipment.*



*Both moving panels slide open smoothly with one-hand operation and close with full interlock seals.*

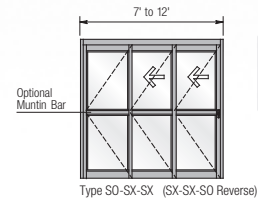

**Type 310T**



### Selection Guide

Model	Type	Unit Width	Max. Clear Opening	Type 110 Breakout Opening	Type 310 Breakout Opening
Profiler®-ICU	Single	7' to 9' (2134-2743)	3' to 4' (914-1219)	3' 3/2" to 4' 3/2" (1003-1308)	6' 3" to 8' 3" (1905-2515)
	Biparting	8' to 16' (2438-4877)	3' to 7' (914-2134)	3' 7" to 7' 7" (1092-2311)	6' 9/2" to 14' 9/2" (2070-4508)
	Telescoping	7' to 12' (2134-3658)	3' 9" to 7' 1" (1143-2159)	—	6' 1" to 11' 1" (1854-3378)
Profiler®-ICU Smoke Rated	Single	7' to 9' (2134-2743)	3' to 4' (914-1219)	3' 3/2" to 4' 3/2" (1003-1308)	6' 3" to 8' 3" (1905-2515)
	Smoke Rated Telescoping ICU/CCU	7' to 12' (2134-3658)	3' 4/4" to 6' 8/4" (1022-2038)	—	6' 1" to 11' 1" (1854-3378)

# Swing & Folding Door Operators & Packages



Whether for new construction or an existing building, Horton Automatics swing and folding door systems provide a full range of access solutions for low energy, handicap, or high-traffic automatic access applications.

## Operator Features

### Series 4000 and Series 7000 Operators

- Adjustable opening and closing speeds
- Adjustable time delay closing (2–30 seconds)
- Push-N-Go® activation
- SoftTouch® safety feature reverses a closing door
- Obstruction sensing reduces opening speed when obstructed



Custom finishes available.

## Options

- Single, pair or double egress door operation
- Choice of in-swing, out-swing, left or right handed operation
- Available as surface applied operator or overhead concealed package complete with door and frame
- Header with bottom or side access

## Applications

One-Way or Two-Way Traffic

- Retail
- Hospitals
- Hotels
- Office Buildings
- Industrial
- Airports
- Government
- Schools and Libraries

*“I just want to say thank you very much for your automatic doors! I am in a wheelchair and your doors simplify my life incredibly.”*

*Briony Chisholm  
Cape Town, South Africa*

## HD-Swing™

### Series 4000 Heavy Duty Universal Operator

Available in our widest range of configurations, the Series 4000 operator is easily adapted in the field for a wide range of commercial uses.

- Choice of header models for surface applied or overhead concealed installations
- Preset for left or right hand operation as ordered, easily modified if desired
- Simple adjustments for full energy (automatic) or low energy (handicap)
- Single acting spring always returns door to closed position, with adjustable speed and force.
- Combine with proper activation (see page 15)

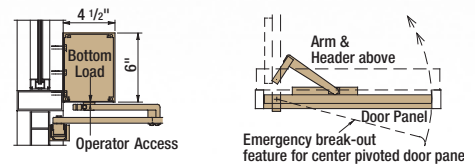
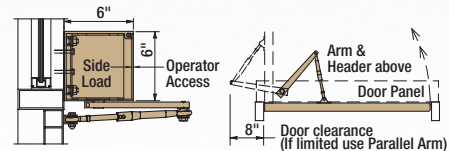
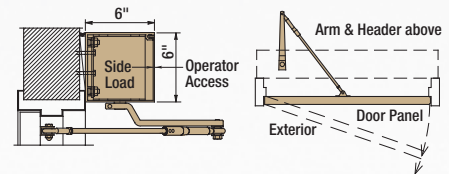

Surface Applied Operator Configurations

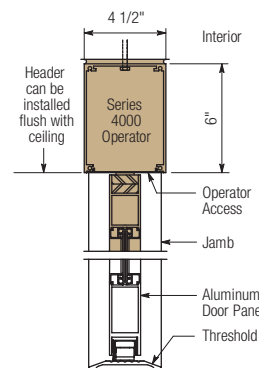

**Series 4500  
Bottom Access  
Direct Drive**

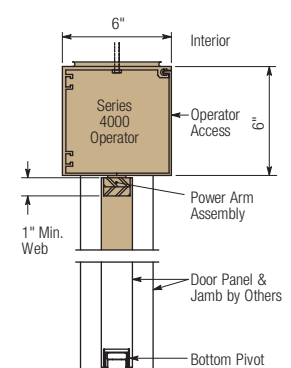

**Series 4800  
Side Access  
Direct Drive**





## EasyAccess™ Series 7000 Low Energy Handicap Operator

The Series 7000 operator is ideal for new or converted barrier-free openings per ANSI A117.1 & A156.19 (ADA).

- Automatic opening with button or push plate activation
- Easily adjustable opening and closing speeds
- Surface applied mounting
- Push-N-Go® feature, SoftTouch® reversing and obstruction sensing
- Available in 4" x 6" or 6" x 6" side access headers

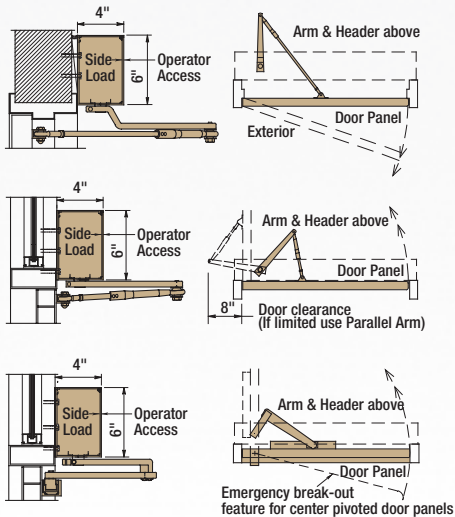

### Surface Applied Operator Configurations



## HD-Swing™ LE Series 4000LE Low Energy ADA Compliant, Heavy Duty Operator

Ideal for use with large, heavy doors required to meet ADA and ANSI A117.1 & A156.19 as well as high traffic hospital environments.

- Easy switching to full energy (automatic) operation
- Heavy duty 1/4 HP drive for taller and heavier doors
- Choice of in-swing, out-swing, left or right handed functions
- Surface applied or overhead concealed mounting in the header
- Available in 4 1/2" x 6" bottom access or 6" x 6" side access header



## FoldingAccess™ Narrow Corridor Folding Door

Ideal for small vestibules and hospital corridors that require wide openings in a narrow corridor. Each FoldingAccess™ door package includes Vista® sensing technology (p.15) for full automatic operation. The system may also be specified for manual operation.

The folding design incorporates the built-in safety of emergency breakout and a low closing force of less than 15 lbs. Available with magnetic lock and panic hardware.

### Standard Features

- Emergency breakout
- Finger guard at all hinge points
- Accommodates one-way or two-way traffic
- Also available in manual opening styles for ICU applications

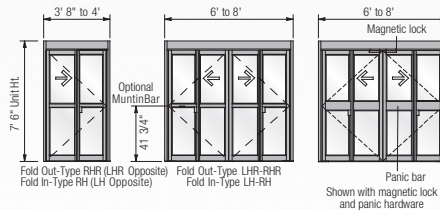

Selection Guide Type	Maximum Clear Opening		Maximum Breakout Opening
	Unit Width	Clear Opening	Breakout Opening
Single (2 panels)	3' 8" to 4'	2' 8" to 3'	2' 11" to 3' 3" (889-991)
Pair (4 panels)	6' to 8'	4' 4" to 6' 4"	4' 11" to 6' 11" (1499-2108)

## Other Swing Door Packages Series 0500 Manual Swing Door

Package includes overhead concealed hydraulic closer with frame and center-pivoted doors. Doors are double-acting and can be right or left hand. This package is often used in multiple door installations where a manual swing door is located next to automatic sliding or revolving doors.



## ICU/CCU Bi-Fold/Bi-Swing™ Multi-Access Combination System

Versatile access of a swing door for normal two-way traffic and an adjacent bi-fold door dramatically increases the opening up to six feet eight inches when moving patients or medical equipment.



*Bi-Fold Door creates additional clearance for patient and equipment moves.*



*Bi-Swing Door opens conveniently in both directions for normal traffic.*

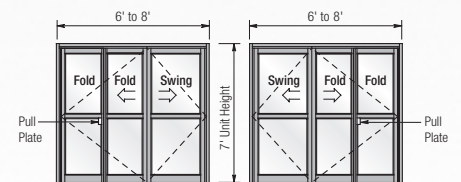

Selection Guide Type	Unit Width	Maximum Clear Opening	Maximum Breakout Opening
	Swing/ Folding	6' to 8' (1829-2438)	4' 8" to 6' 8" (1422-2032)

## SmokeSwing Doors

Available in single, equal pair and unequal pair door widths up to 48" per leaf.



## Other Specialty Operators Series 4700 Super Duty Swing Door Operator

The opening and closing force provided by this surface applied operator is adjustable and delivers substantial torque at the output shaft. With its 1/4 HP motor, the Series 4700 can operate extremely heavy doors such as lead-lined doors used in hospital X-ray rooms.



# Automatic Revolving Doors



Horton Automatics revolving door systems offer impressive architectural appeal, energy efficiency and effective high traffic management.

Five major design series are offered in a wide selection of finishes, diameters, door wing configurations, glazing options, sensors and security systems.

## Standard Features

- Constant seal helps control heating/cooling costs, eliminating dust, drafts and noise
- Segmented® or round drum design
- Magnetic breakaway door wings for emergency egress
- Bump-To-Idle™ for added safety
- Easily adjustable manual or automatic rotation
- One-way, two-way or card access security
- Easy manual operation during power outages
- Most models are easily customized with all glass, solid wood and stainless steel materials plus special roof panel designs and extended canopies
- Compliance with ANSI 156.27 revolving door standard

## Optional Features

- Available with quadrant heater for interior comfort in cold climates

## Applications

High Traffic, Energy Efficiency, Security

- Airports
- Hospitals
- Hotels
- Schools
- Restaurants
- Manufacturing Facilities
- Financial/Government
- Shopping Malls and Retail
- Upscale Condominiums
- Call Centers
- Traffic Management

## Grand®

### 9600 Series Large Diameter Vestibule System

Spacious compartments provide an elegant, energy-efficient entrance up to 16 feet in diameter to manage high volume traffic needs including shopping carts, bicycles, wheel chairs, walkers and even hospital stretchers.

#### Standard Features

- Segmented® or round drum design
- Panels fold against the core for emergency egress
- Smooth, continuous rotation
- VistaScan™ electronic sensing system slows or stops the door when objects are within 8" to 12" of the wings
- Customizable voice enunciator

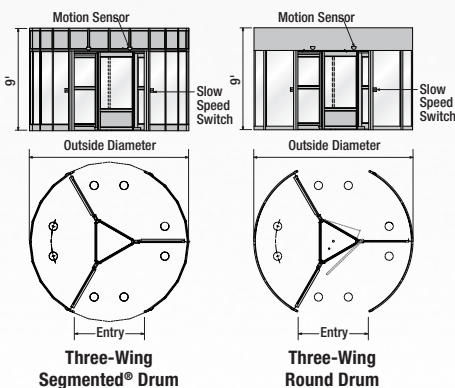

Selection Guide		
Outside Diameter	Segmented® Drum	Round Drum
	Entry - Three-Wing	Entry - Three-Wing
12' (3658)	5' 3 3/4" (1619)	5' 1 5/8" (1565)
14' (4267)	6' 3 3/4" (1924)	6' 1 5/8" (1870)
16' (4877)	7' 3 3/4" (2229)	7' 1 5/8" (2175)

*Horton Grand Revolvers are featured at New York's LaGuardia airport. 16' 3-wing units add drama to the airport architecture while providing the ability to move large volumes of traffic.*

## MiniGrand®

### 9300MG Series Automatic Entrance System

The MiniGrand® offers the drum construction of a Grand® and the center shaft and door wing construction of an AutoFlow™.

#### Standard Features

- Segmented® or round drum design
- Smooth continuous rotation
- Auto rotation with VistaScan™

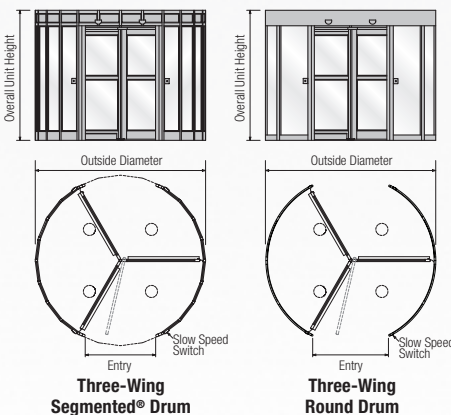

Selection Guide		
Outside Diameter	Segmented® Drum	Round Drum
	Entry - Three-Wing	Entry - Three-Wing
11' (3353)	4' 9 3/4" (1467)	4' 7 5/8" (1413)
12' (3658)	5' 3 3/4" (1619)	5' 1 5/8" (1565)

*Three-wing revolving doors with polished brass finished are featured at the Paris Hotel in Las Vegas. These custom made doors were designed to match the European style of the construction and handle hundreds of thousands of visitors every year.*

# Security Revolving Doors



## ControlFlow™ 9200 Series Automatic Security Door System

Available in a choice of One-Way, One-Way Airport and Two-Way Card Access security packages, this system has selectable security levels. Add optional Level III bullet resistant glazing and Visdom HS® advanced 3D anti-piggybacking/anti-tailgating prevention sensors (page 12) for ultimate protection in banks/financial, government and other high security installations.

### Standard Features

- Segmented® or round drum design
- Overhead sensors in place of mats
- Wireless remote setup with 16 modes of operation and other programming options
- Field programmable voice messages
- Magnetic breakaway for emergency egress
- Choice of anodized aluminum, paint or metal clad finishes
- Special sizes, extended canopy and other options available



*Horton installed the first ever Security Object Detection Revolving Door at Albuquerque International Airport. Ask us how your facility can benefit from Horton's Visdom HS® Object Detection System.*

*Horton's ControlFlow™ provides security at the Canadian Imperial Bank of Commerce, one of the largest financial institutions in Canada.*



## ControlFlow™ One-Way Security Series 9100

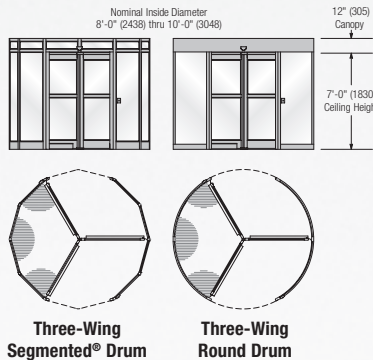

## ControlFlow™ One-Way Security Series 9100AP

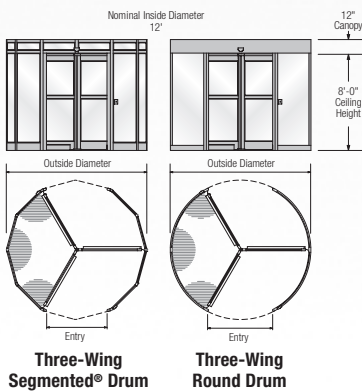

## ControlFlow™ Two-Way Card Access Security Series 9200

### With Anti-Tailgate Security

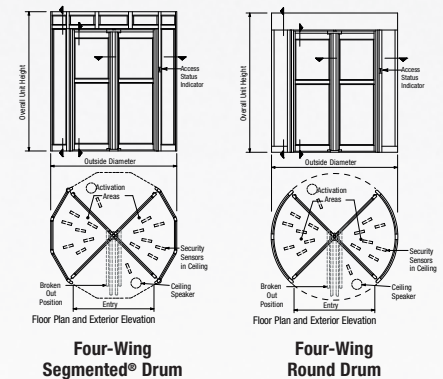

### With Anti-Tailgate and Anti-Piggyback Security

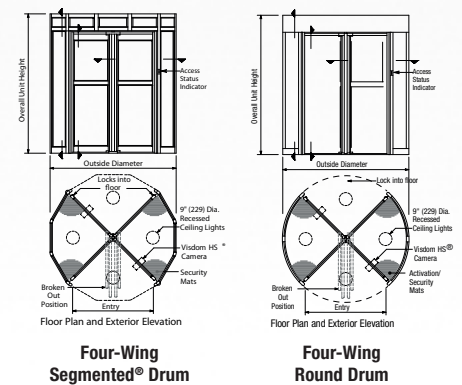

### Selection Guide

Model	Type	Outside Diameter	Segmented® Drum Entry	Round Drum Entry
<b>ControlFlow™ One-Way</b>	Three-Wing	8' 3/8" to 10' 3/8" (2527–3137)	3' 4/8" to 4' 4/8" (1026–1330)	3' 6/8" to 4' 6/8" (1089–1394)
<b>ControlFlow™ One-Way Airport</b>	Three-Wing	12' (3658)	5' 3/4" (1619)	5' 1/8" (1565)
<b>ControlFlow™ Two-Way Anti-Tailgating</b>	Four-Wing	6' 3/8" to 7' 3/8" (1918–2223)	3' 10" to 4' 6/4" (1168–1391)	3' 10" to 4' 7/8" (1191–1406)
<b>ControlFlow™ Two-Way Anti-Tailgating/Anti-Piggybacking</b>	Four-Wing	6' 3/8" to 7' 3/8" (1918–2223)	3' 10" to 4' 6/4" (1168–1391)	3' 10" to 4' 7/8" (1191–1406)

# Manual Revolving Doors



## AutoFlow™

### 9300 Series Automatic Entrance System

With this hands-free entrance system, motion detectors at each opening start door rotation on user approach. A reduced speed feature slows the rotation for wheelchairs, strollers and other slower traffic. The unit is microprocessor controlled with wireless remote speed adjustment, self-diagnostic display for service and voice messages including four field-programmable voice prompts.

#### Standard Features

- Segmented® or round drum design
- Standard 10' diameter
- Curved tempered or laminated wall glass
- Three-wing with medium stiles
- Virtually unlimited custom features: finishes, special diameters and heights, ceiling lights, all-glass ceiling, VistaScan™ and FootGuard™ safety features, AutoLock™ automatic after-hours locking, EntryGuard™ late entry protection and more

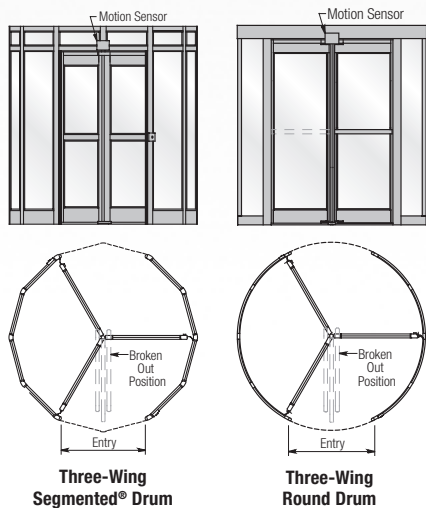

#### Selection Guide

Outside Diameter	Segmented® Drum	Round Drum
	Entry - Three-Wing	Entry - Three-Wing
10' (3048)	4' 4 3/4" (1340)	4' 7 3/4" (1407)



## EasyFlow™

### 9500 Series Manual Door System

An outstanding choice for energy efficiency along with architectural appeal, the EasyFlow™ series is offered in a variety of configurations to suit any installation requirement. Each system includes Horton's proven mechanical speed control and book-fold hardware for emergency egress.

#### Standard Features

- Segmented® or round drum design
- Four standard diameters 6' to 8'
- Curved tempered or laminated wall glass
- Push bars or muntins
- Choice of finishes
- Broad range of specifier options including all glass Elegant® models, special diameters and heights, lighted and all-glass ceilings, electronic speed control and other custom touches

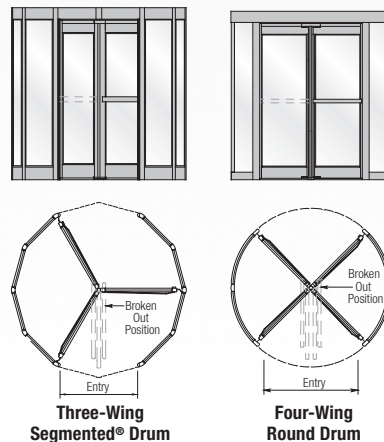

#### Selection Guide – Segmented® Drum

Outside Diameter	Entry - Three-Wing	Entry - Four-Wing
6' (1829)	—	4' 2 3/4" (1280)
6' 6" (1981)	3' 1/8" (918)	4' 6 3/4" (1391)
7' (2134)	3' 3" (991)	4' 11 1/8" (1502)
8' (2438)	3' 9" (1143)	5' 7 3/4" (1724)

#### Selection Guide – Round Drum

Outside Diameter	Entry - Three-Wing	Entry - Four-Wing
6' (1829)	—	4' 3/4" (1238)
6' 6" (1981)	3' 1/8" (918)	4' 5" (1346)
7' (2134)	3' 3 1/8" (994)	4' 9 1/4" (1454)
8' (2438)	3' 9 1/8" (1146)	5' 5 3/4" (1670)

## Sensors for Revolving Doors

Activation components for revolving doors are available for directional security and entry protection. Horton ControlFlow™, AutoFlow™ and Grand® revolving systems include the appropriate devices for each application.

Most revolving door sensing packages include motion detection on both sides for door activation. Additional sensing may include a top-of-wing mounted VistaScan™ sensor to slow or stop door rotation if someone is near the wing, a FootGuard™ contact switch and EntryGuard™ infrared sensing of interior/exterior entrance zones and other detection electronics.

## High Security

For revolving door entrances in airports, R&D labs and other facilities where unauthorized objects or entry violations are a concern, the Visdom HS® system is the ultimate security solution. Its sophisticated 3D technology can be applied two ways:

#### Object Detection

- Reduces threat of unidentified objects entering a secure environment
- Array of sensors detects, stops and captures violating objects
- Audible alarm notifies personnel
- System automatically resets after violation is rectified

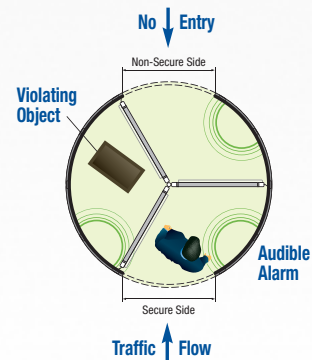

## Visdom HS™

#### Anti-Piggyback / Anti-Tailgate Security

- Discerns between would-be intruders and authorized personnel
- User-selectable security levels for one or more violators
- Unaffected by shadows, reflections and environmental changes
- RS170 output via standard RCA connector
- Displays and records the intrusion with time stamp



# Industrial Sliding Door Systems



With up to 12 feet stroke and 500 lbs. of weight capacity, these door systems are engineered for general industrial as well as sterile environments. Select operators only or complete packages with steel, aluminum, fiberglass or stainless steel doors plus tracks, operator and activation devices to suit your requirements.

## Typical packages include:

- Floor mounted guides
- Photoelectric beams placed parallel to the door opening
- Fast-acting HD-Slide™ operators for industrial installations
- Linear drive operators for washdown applications

Consult factory for explosion-proof systems or for assistance with special applications.

## Applications

Two-Way Traffic, Industrial

- Warehouses
- Pharmaceutical/Biotechnology
- Cleanrooms
- Food Processing
- Chemical Processing
- Other Industrial

## RapidSlide™ Lightweight Steel Door System

Thermacore® insulated steel door assembly has 24" (610 mm) modular sections constructed of metal/foam/metal sandwich for maximum energy efficiency.

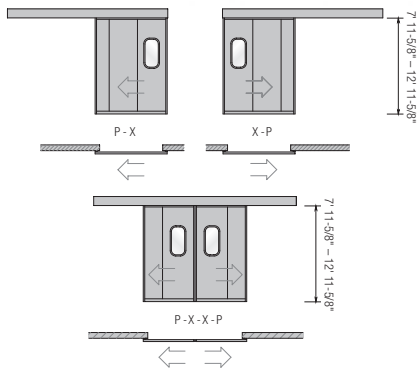

### Selection Guide

Type	Overall Unit Width	Maximum Slide Opening
Single Slide	13' 2" to 25' 2" (4013-7671)	6' to 12' (1829-3658)
Bi-Parting Slide	13' 3" to 25' 3" (4039-7696)	6' to 12' (1829-3658)

## HD-Slide™ Industrial With Hollow Metal Panel

### Heavy Duty Industrial Door System

Utilizes 18 or 20 gauge galvanized steel skin doors with Kraft honeycomb core. Interior framing channels are 14 gauge steel. Panels have a flush appearance with no exposed fasteners.

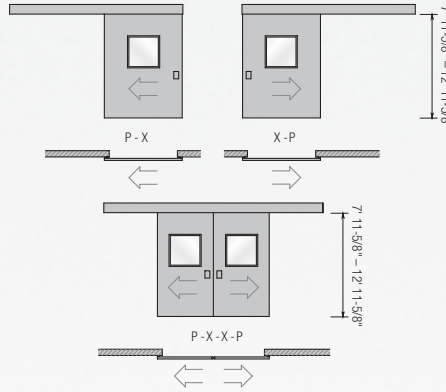

### Selection Guide

Type	Overall Unit Width	Maximum Slide Opening
Single Slide	11' 3" to 21' 3" (3429-6477)	5' to 10' (1524-3048)
Bi-Parting Slide	11' 5" to 25' 3" (3480-7696)	5' to 12' (1524-3658)

## HD-Slide™ Industrial With Aluminum & Glass Panel

### Full View Industrial Door System

Full vision panels with mechanical joints have medium stile (5" wide) vertical rails and 6-1/2" bottom rail. Glazing prep is for 1/4" glass. Glass by others.

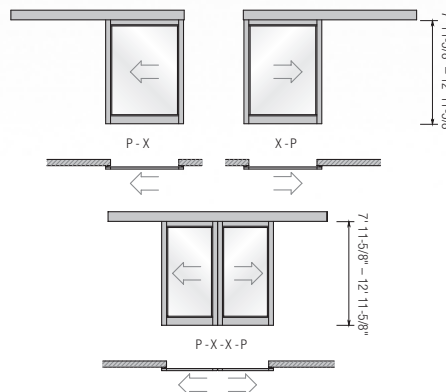

### Selection Guide

Type	Overall Unit Width	Maximum Slide Opening
Single Slide	9' 2" to 21' 2" (2794-6452)	4' to 10' (1219-3048)
Bi-Parting Slide	13' 3" to 25' 3" (3962-7696)	6' to 12' (1829-3658)

*Horton Industrial systems are available in pneumatic and explosion-proof configurations.*



## UltraClean™ I

### Atmospheric Sliding Doors

Designed to meet ISO 14644-1 Class 3 cleanroom applications, these door packages feature positive seal, vinyl weatherstrip and touchless wall-mounted scanner activation. Electrical interlocks for sequential operating of up to 10 doors and pneumatic, explosion-proof operator packages are also available.

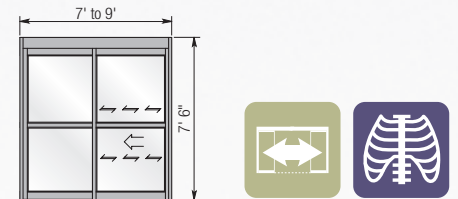

### Selection Guide

Type	Overall Unit Width	Maximum Slide Opening
Single Slide	7' to 9' (2134-2743)	3' to 4' (914-1219)

## Bio-Slide

### Washdown Door System

With brushed stainless steel doors and optional 10" (254 mm) or 24" (610 mm) vision lites, this sliding door system is commonly used in bio-hazard areas requiring frequent washdown. Standard features include belt drive electric operator and touchless wall-mounted scanner activation. Pneumatic operators, special door finishes as well as pull chain, push plate or motion sensor activation are among options available.

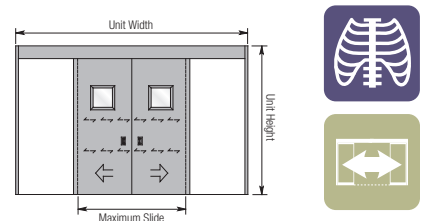

### Selection Guide

Type	Overall Unit Width	Maximum Slide Opening
Single Slide	7' to 9' (2134-2743)	3' to 4' (914-1219)
Bi-Parting Slide	9' to 16' (2743-4877)	3' 6" to 7' (1067-2134)



## Drive-Thru Service Windows

Automatic • Security • Manual

Horton service windows are a standard specification for leading restaurant chains, pharmacies and other companies that have discovered how drive-thru service can enhance their business. These custom systems utilize proven Horton automation and construction details including aluminum header and corner-block construction.

Units can be customized with transaction drawers, up to 1" insulated glass, bullet resistant glass, a variety of counter tops such as stainless steel and other specifier options. The windows open and close automatically when activated by Horton's HipScan™ or WinScan™ actuator and can also be opened manually if there is a power outage. An optional automatic lock secures the window each time it closes.

### Standard Features

- Auto-close and reverse-on-contact functions
- Maximum security lock
- Fully assembled and glazed for easy installation
- Several optional finishes (anodized aluminum, paint, metal clad)

### Applications

- Pharmacies
- Restaurants
- Banks/Financial
- Dry Cleaners
- Labs/Supply Rooms
- Reception Areas
- Other Secure Areas

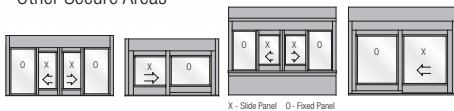

### Selection Guide

Window/Unit Type	Size	Maximum Slide Opening
<b>2 Panel</b> O-X or X-O	45½" to 50" (1156 to 1270)	16" to 20½" (406 to 521)
<i>With 1" insulated glass or ½" prep without glass. Also available with recessed pull</i>		
<b>2 Panel – Security</b> O-X/O-X or X-O/X-O	50¼" (1276)	20½" (521)
<i>With synchronized interlocking slide panels</i>		
<b>4 Panel</b> O-X-X-O	53½" (1359)	21" (533)
<i>With thin stile panels, ½" tempered glass Also available with ½" glass canopy, stainless steel counter and metal apron</i>		



Designed for public and private transit complexes, this equipment is installed as an integral part of Automated People Mover (APM) systems. Horton Automatics has been developing these custom systems for more than 35 years with installations in major transportation hubs throughout the world.

## Applications

- Airports
- Resort Hotels
- Public Transit
- Theme Parks
- Transit Vehicles
- Subways

## Design Options

- Station Platform Screen Doors (PSD)
- Transit System Sliding Doors
- Automatic Train Control (ATC) Monitoring
- Transit Vehicle Door Operators
- Emergency Egress Door (EED)
- Control Panels
- Full Barrier Wall

All systems enhance communication between components that govern operating functions. The systems are designed for long life, high reliability and maximum safety per ASC APM Standards. For information about a custom engineered transit system, contact Horton Automatics.

The barrier wall design option includes all the supporting structure for the platform doors which results in shorter installation time and fewer trades to coordinate.

*Horton transit door systems are in more than 45 major airports worldwide including Frankfurt, Kuala Lumpur, Singapore, Rome, Beijing, Heathrow, Seoul, Madrid, Toronto, DFW, Houston and Las Vegas.*



Toronto Airport

## Selected Worldwide Installations

- Hartsfield-Jackson International Airport, Atlanta, Georgia
- Heathrow Airport, London, United Kingdom
- Frankfurt am Main Airport, Frankfurt, Germany
- Dulles International Airport, Washington DC
- Kuala Lumpur International Airport, Sepang, West Malaysia
- Toronto Pearson International Airport, Toronto, Canada
- Beijing Capital International Airport, Beijing, China
- Benito Juárez International Airport, Mexico City, Mexico
- Incheon International Airport, Seoul, South Korea
- Dallas/Fort Worth International Airport, Dallas, Texas
- Las Vegas Monorail, Las Vegas, Nevada
- Guadalajara BRT, Guadalajara, Jalisco, Mexico
- Transmilenio BRT, Bogotá, Colombia
- Metrovia BRT, Guayaquil, Ecuador

*"Bombardier has selectively chosen Horton Automatics to support its APM projects based upon their proven ability to meet stringent technical, quality and schedule requirements with focus to maintain or better established budget."*

Bombardier Transportation

# Activation, Safety & Accessories

## Sensors for Swinging Doors, Folding Doors

Horton Vista™ sensor packages include systems with varying degrees of presence detection. Basic systems incorporate a microwave or active infrared sensor on the approach side with presence sensors and infrared Sentinel™ photo beam on the swing side. Enhanced Vista™ systems add door mounted presence sensors to each side of the swinging door panel. Guide rails are normally specified on the swing side (or fold side of folding doors) per ANSI A156.10. Two rails are required if a wall or barrier is not present.

### Vista™ Sensor System

Part No	Description	Type
C1884 or C1234	Choice of Microwave Motion Sensor OR Active Infrared Motion/Presence Sensor	Activation
C1829	Active Infrared Sensor	Safety
C7783	Photo Beam (Wall or Guide Rail Mounted)	Safety
C1878-2	Door Mounted Presence Sensor (Each Side of Door)	Safety

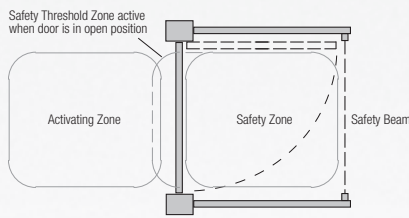

Swinging Doors

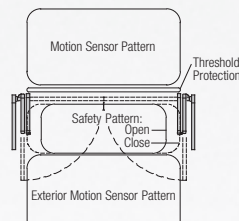

Bifolding Doors

### Low Energy Activation and Safety Options

Part No	Description	Type
C1829	Infrared Presence Detection	Optional Safety
C7783	Safety Beam Set	Optional Safety
C1260-5*	4 1/2" x 4 1/2" Stainless Steel Switch	Optional Activation
C1260-5RC*	4 1/2" x 4 1/2" Wireless Stainless Steel Switch	Optional Activation

\* Both with international handicap logo

### Touchless Sensors

Part No	Description	Type
C8140	1 5/8" x 4" Infrared Brushed Stainless Steel	Touchless Sensor
C8147	2 3/4" x 4 1/2" Microwave Black Polycarbonate	Optional Activation

## Sensors for Sliding Doors

All dual systems utilize infrared reflective or microwave sensing on both sides for two-way traffic activation. In addition, Horton includes photo beam sensors mounted in the sidelite or frame at 24" and 48" from the floor to prevent closure when an obstacle or pedestrian is in the opening.

Part No	Description	Type
C1827**	Microwave Motion/Active Infrared Presence	Optional - Activation/Safety
C1238**	Active Infrared Motion/Presence	Optional - Activation/Safety
C7775	Dual Transmitter/Receiver Photo Beams	Redundant Safety

\*\* A standard sliding door system features a pair of either of these sensors

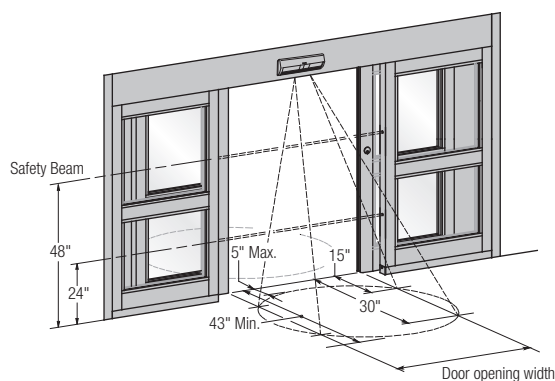

## Activating Switches

Horton specialists will help you specify the correct switch for your requirements, including:

- Round or square metal push plates
- Push-button
- Keyless digital-code entry
- Key switch
- Electric mat
- Touchless photoelectric wall switch
- Explosion-proof solid state switch
- Touchless Sensors

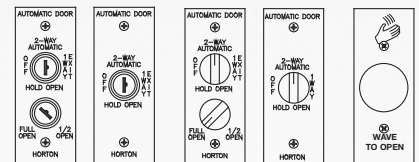
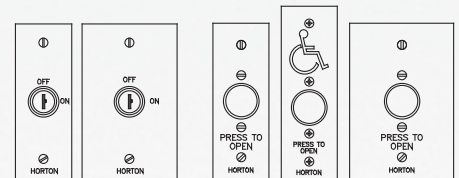

### Did You Know?

*Horton Automatics is the only manufacturer that offers dual photobeam and presence sensing technology to protect pedestrians at the threshold.*

## Setting The Standards For Professional Installation And Service



Horton Automatics brings you the professional support of factory-authorized distributors. Whether your application involves a single automatic operator or a complete facility access and security plan, you can expect all phases of the project to be handled professionally.

All Horton systems are built to exceed applicable quality and safety standards including:

- ANSI standards for pedestrian doors
- 1990 ADA requirements for barrier-free entrances
- Tested to UL 1784 to meet National Fire Protection Association (NFPA) regulations
- National building codes related to emergency exit
- American Testing Laboratory ratings for wind load and forced entry
- CSA, IBC, Miami-Dade, BOCA, and other regional requirements
- Listed by Intertek (ETL) for compliance to UL 325 Electrical Door, Drapery, Gate, Louver, and Window Operators and Systems

Call your Horton Automatics distributor today for design, specification and application assistance. Visit [www.hortondoors.com](http://www.hortondoors.com) to find the nearest distributor in your area.

**Specify Horton and demand AAADM certified installation.**

**AAADM** *American Association of Automatic Door Manufacturers*

Horton Automatics is a division of Overhead Door Corporation, an innovative industry leader with many firsts in upward-acting doors and electric openers for residential as well as commercial applications.



**Horton Automatics**  
**World Headquarters**  
4242 Baldwin Boulevard  
Corpus Christi, Texas 78405-3399 USA  
Phone: 800-531-3111, 361-888-5591  
Fax: 361-888-6510  
[www.hortondoors.com](http://www.hortondoors.com)

**Horton Automatics, Ltd.**  
**United Kingdom**  
Unit A, Hortonwood 31  
Telford, Shropshire, England TF1-7YZ  
Phone: 01952 670169  
Fax: 01952 670181



*Horton Automatics is a division of Overhead Door Corporation, an innovative industry leader with many firsts in upward-acting doors and electric openers for residential as well as commercial applications.*

*Specify*   
**HORTON**